

INTESTINAL AND RECTAL INSTRUMENTS



Allis Baby Tissue Forceps
 15-101-13 13cm
 15-102-14 14cm
 3 x 4 teeth



Allis Tissue Forceps
 15-103-15 15 cm
 3 x 4 teeth



Allis Baby Tissue Forceps
 15-104-12 12cm
 15-105-14 14cm
 4 X 5 teeth

KUMMAS
 CORPORATION

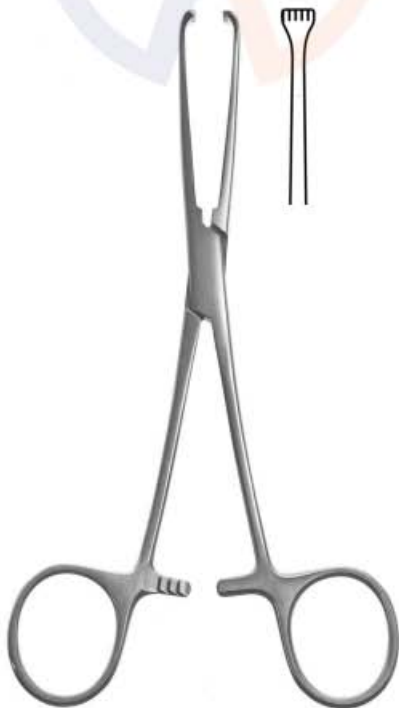

Allis Tissue Forceps
 15-106-15 15.5 cm
 4 x 5 teeth



Allis Tissue Forceps
 15-107-16 16 cm
 15-108-19 19 cm
 15-109-22 22 cm
 15-110-25 25.5 cm
 5 x 6 teeth



Judd-Allis Tissue Forceps
 15-111-15 15 cm
 15-112-19 19.5 cm
 3 x 4 teeth



Boys-Allis Tissue Forceps
15-113-15 15.5 cm
5 x 6 teeth



Allis Tissue Grasping Forceps
Atraumatic Parallel Serrations

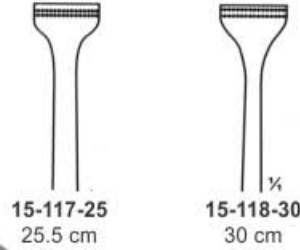
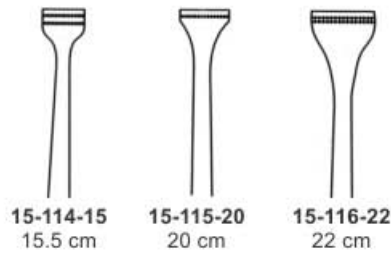

Allis-Adair
15-119-16
16 cm
9x10 teeth



Thoms-Allis
15-120-20
20.5 cm
6x7 teeth



Williams Grasp Forceps
15-121-16 16 cm



Chaput Tissue Forceps
15-122-13 13 cm
2 x 3 teeth

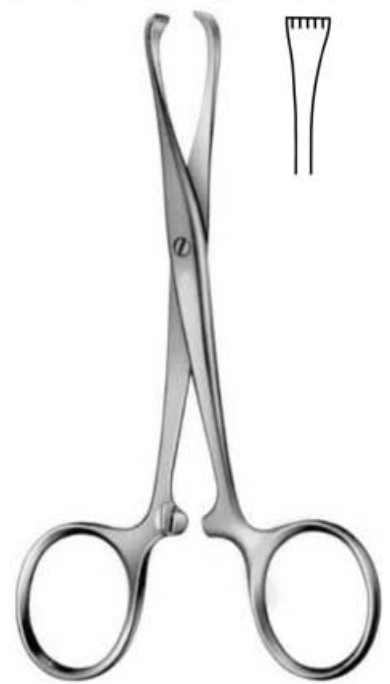

Tuffier Tissue Forceps
15-123-13 13 cm
5 x 6 teeth



TISSUE GRASPING FORCEPS

Gewebefasszange

Fórceps de agarre de tejido

Pince à préhension tissulaire

Pinza per la presa dei tessuti



Babcock Tissue Forceps

15-124-16
16 cm
15-125-18
18 cm
15-126-20
20 cm
15-127-22
22 cm
15-128-24
24cm



**Babcock Tissue Grasping
Forceps
Atraumatic Parallel Serrations**

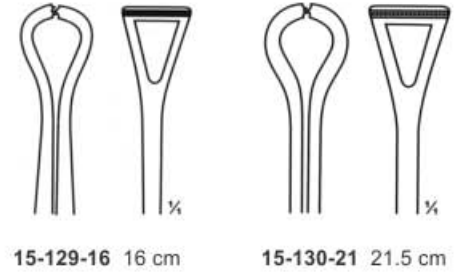

15-129-16 16 cm

15-130-21 21.5 cm



**Little Wood Tissue Grasping
Forceps**
15-131-19 19 cm
2x3 teeth



**Lane Tissue Grasping
Forceps**
15-132-12 12.5 cm
15-133-15 15 cm
15-134-19 19 cm
1x2 teeth

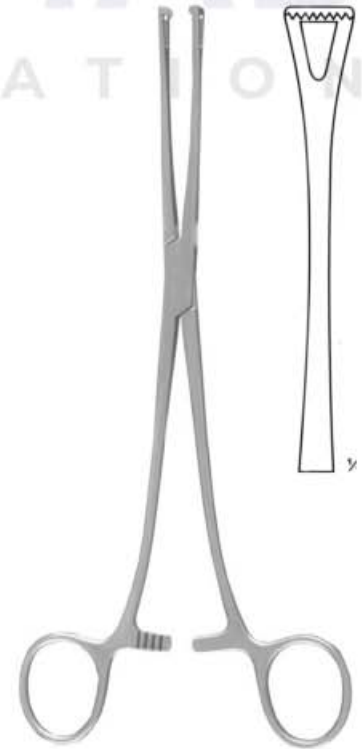

Lockwood Grasp Forceps
15-135-20 20 cm

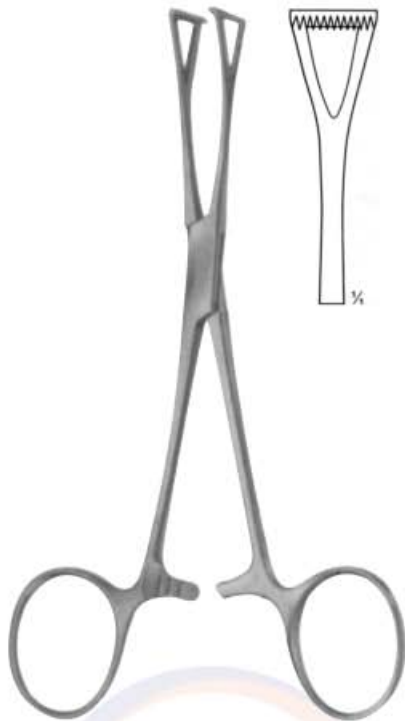

Collin Grasp Forceps
15-136-14 14 cm

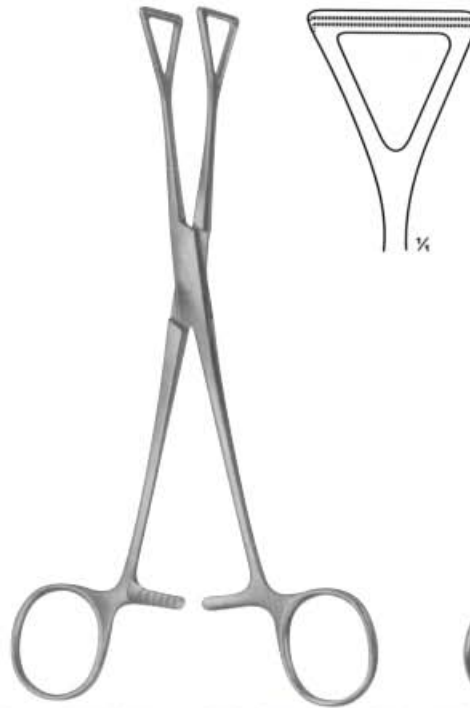

**Collin
Tissue Grasping Forceps**
15-137-19 19.5 cm

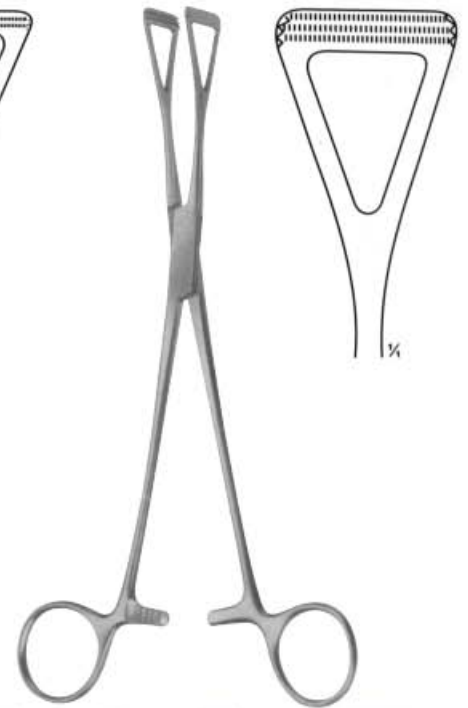

**Collin
Tissue Grasping Forceps**
15-138-23 23 cm

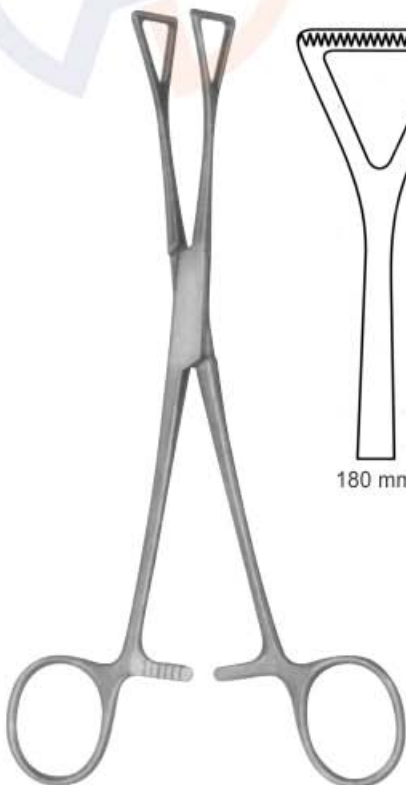

Duval-Collin Grasp Forceps
15-139-18 18 cm
15-140-20 20 cm



Duval Grasp Forceps
15-141-23 23 cm



Scheibe
Organ Grasping Forceps

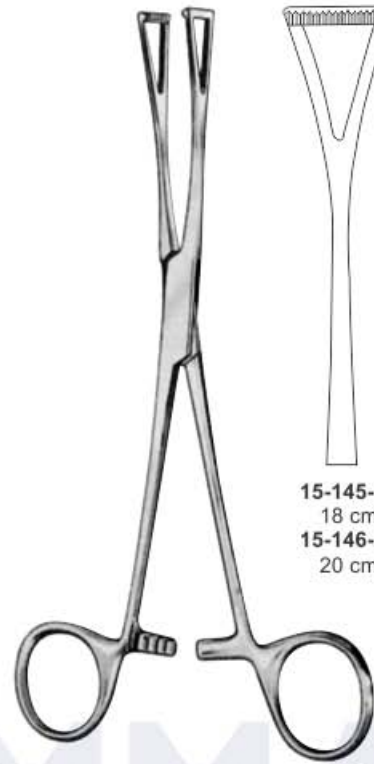
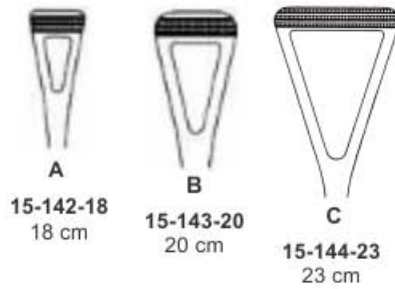

Duval Tissue Grasping Forceps

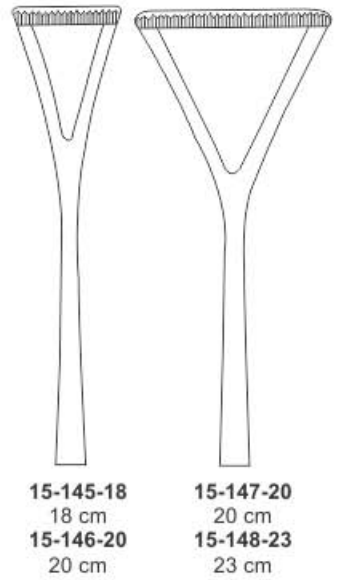

Duval Lung Tissue Forceps
15-149-25
DeBakey type jaw, 23 cm
25.4mm WIDE



Lovelace Lung Tissue Forceps
15-150-25
Angled on Side,
DeBakey type jaw, 19 cm
25.4mm WIDE



Heywood-Smith
15-151-21
Polypus Grasping Forceps
21 cm

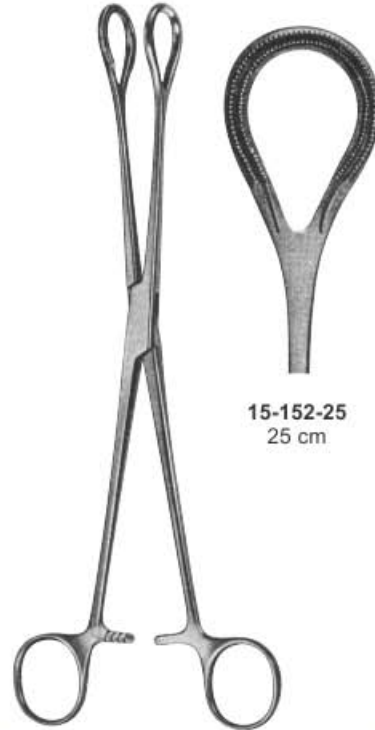

15-152-25
25 cm



15-153-27
27 cm

**Intestinal and Tissue
Grasping Clamp Forceps**



**Babcock Intestinal & Tissue
Grasping Clamp Forceps T.C Inserts**



15-154-16
16.5 cm

15-155-20
20.3 cm



15-156-17
17.5 cm

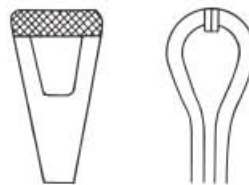

15-157-19
19.5 cm



**Duval Intestinal & Tissue Grasping
Clamp Forceps T.C Inserts**



15-158-13
13 cm

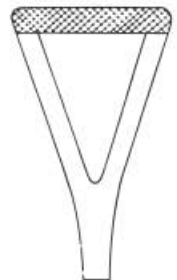

15-159-18
18 cm
15-160-20
20 cm

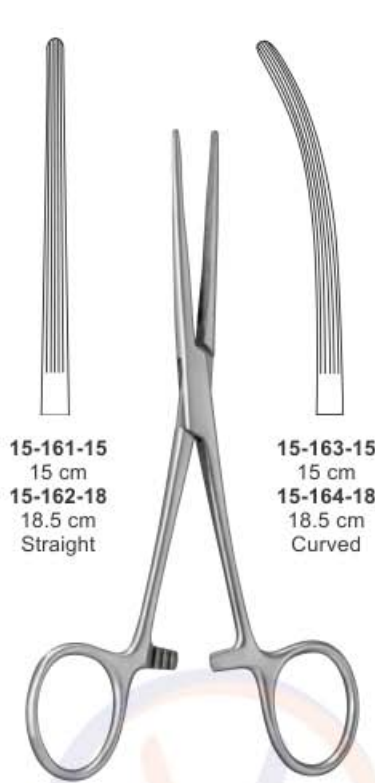

15-161-15
15 cm
15-162-18
18.5 cm
Straight

15-163-15
15 cm
15-164-18
18.5 cm
Curved

**Bainbridge Haemostatic
Forceps**

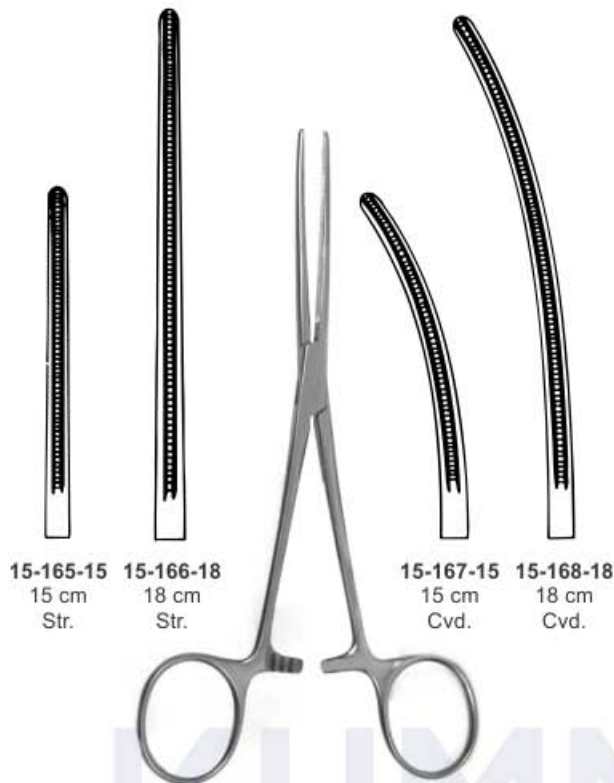

15-165-15
15 cm
Str.

15-166-18
18 cm
Str.

15-167-15
15 cm
Cvd.

15-168-18
18 cm
Cvd.

**Bainbridge Intestinal
Forceps Clamps**

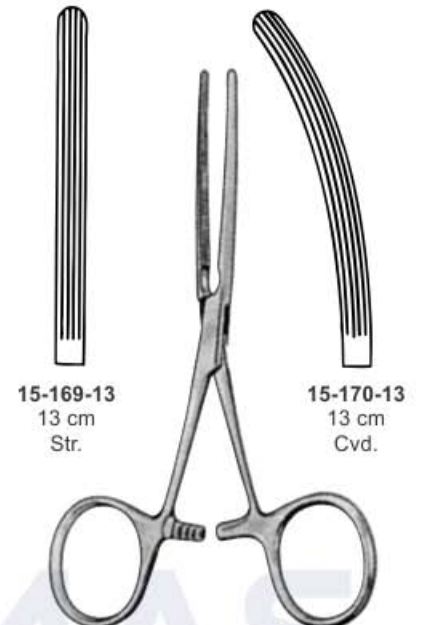

15-169-13
13 cm
Str.

15-170-13
13 cm
Cvd.

**Baby-Kocher
Intestinal Forceps Clamps**

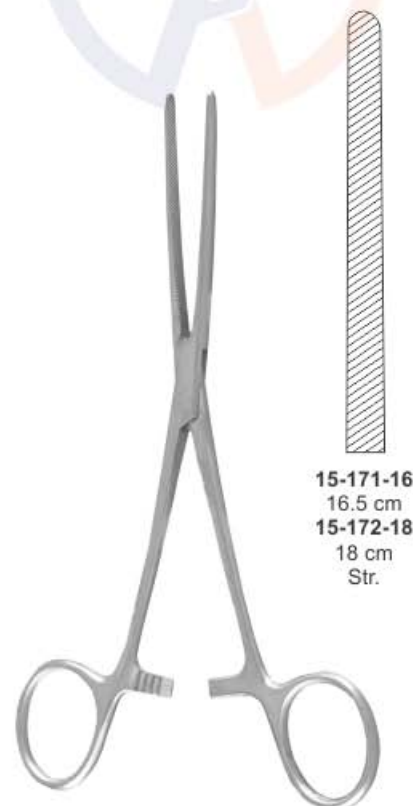

15-171-16
16.5 cm
15-172-18
18 cm
Str.

**Doyen Intestinal
Forceps Clamps**

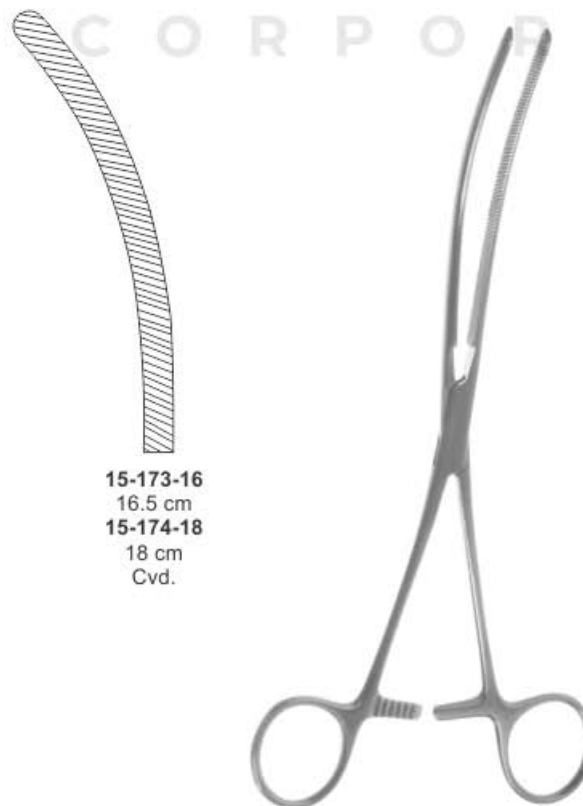

15-173-16
16.5 cm
15-174-18
18 cm
Cvd.

**Doyen Intestinal Forceps
Clamps**

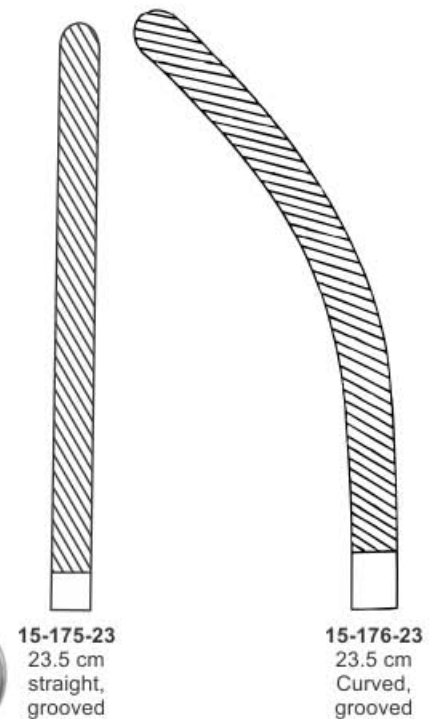

15-175-23
23.5 cm
straight,
grooved

15-176-23
23.5 cm
Curved,
grooved

INTESTINAL AND STOMACH FORCEPS

Darm- und Magenlange

Fórceps intestinales y estomacales

Pinces intestinales et stomacales

Forcipe intestinale e addominale

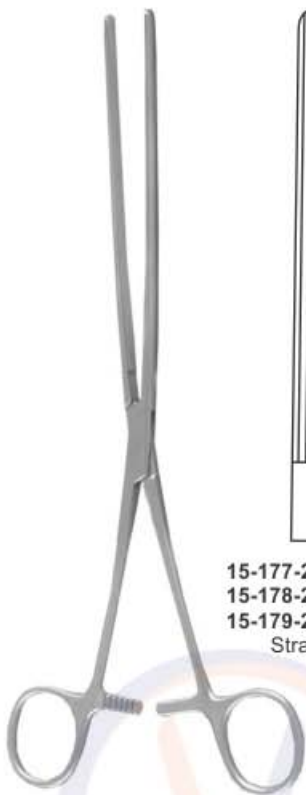

Mayo-Robson Intestinal Forceps Clamps

15-177-21 21cm
15-178-23 23cm
15-179-25 25cm
Straight



15-180-21 21cm
15-181-23 23cm
15-182-25 25cm
Curved



Mayo Vessel Clamp
15-183-25 25.5cm
Curved, 3.8cm tip



Hayes Sigmoid Anastomosis Forceps

15-184-27 27 cm
15-185-28 28 cm



Allen Intestinal Clamp
15-186-16 16cm



Brunner Intestinal Polyous Grasping Forceps
15-187-24 24cm



Resano Intestinal Polyous Grasping Forceps
15-188-30 30cm



Fehland Intestinal Polyous Grasping Forceps
15-189-24 24 cm

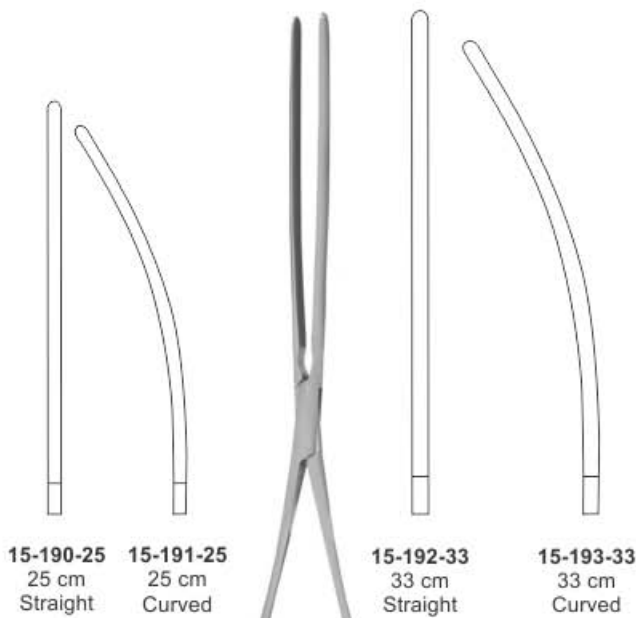

Scudder Intestinal Forceps Clamps

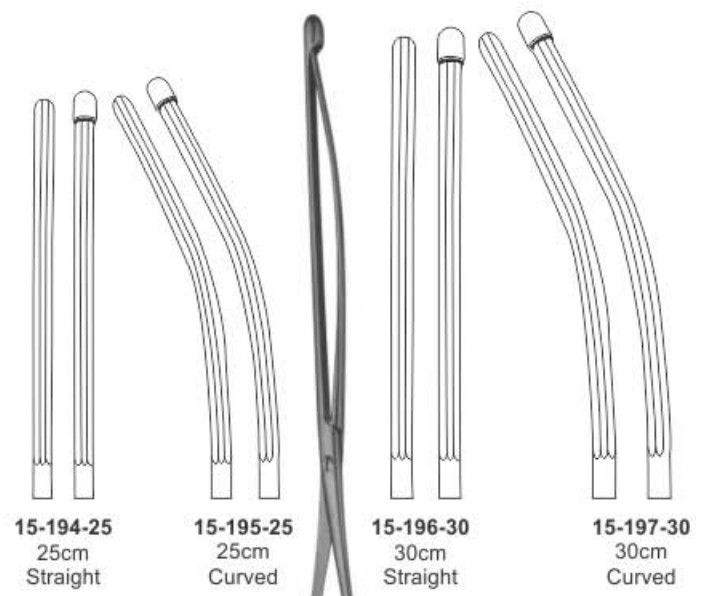

Nussbaum Intestinal Forceps Clamps



Kocher Intestinal Forceps Clamps

INTESTINAL AND STOMACH FORCEPS

Darm- und Magenlange

Fórceps intestinales y estomacales

Pinces intestinales et stomacales

Forcipe intestinale e addominale



15-204-20
Straight



15-205-20
Curved



HARTMANN
with elastic blades
20cm



15-206-20
Straight



15-207-20
Curved



HARTMANN
with elastic blades
20cm



15-208-21
Straight



15-209-21
Curved

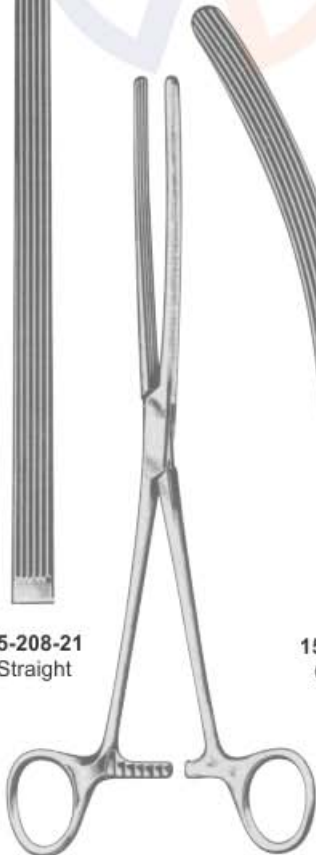

KOCHER
with elastic blades
21cm

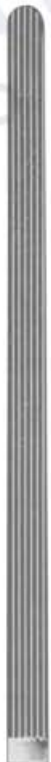

15-210-23
Straight



15-211-23
Curved

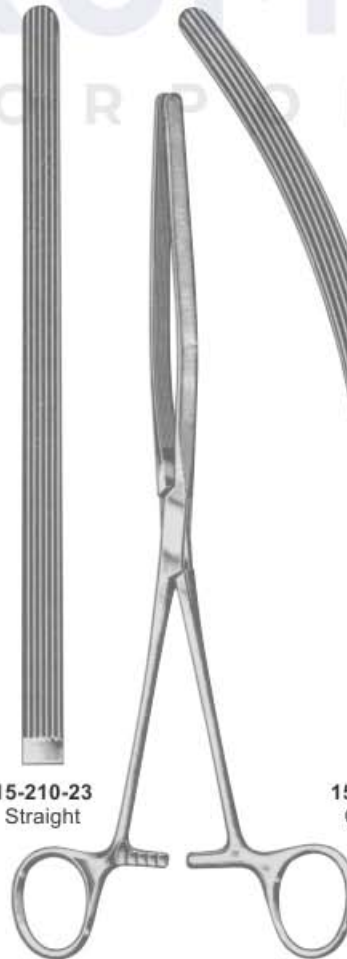

KOCHER
with elastic blades
23cm



MOYNIHAN
15-212-29
29cm



**Doyen Intestinal
Forceps Clamps**

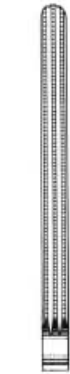

15-213-13
13 cm
Straight



15-214-16
16 cm
Straight



15-215-18
18 cm
Straight



15-216-21
21 cm
Straight

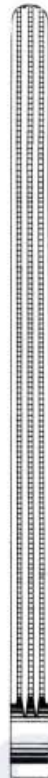

15-217-23
23 cm
Straight

KUMMAS
CORPORATION



**Doyen Intestinal
Forceps Clamps**



15-218-13
13 cm
Curved



15-219-16
16 cm
Curved

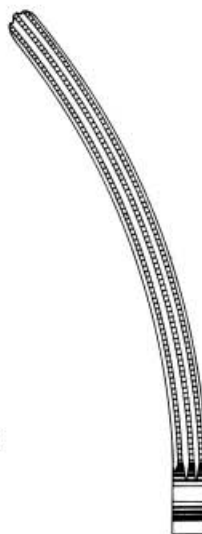

15-220-18
18 cm
Curved

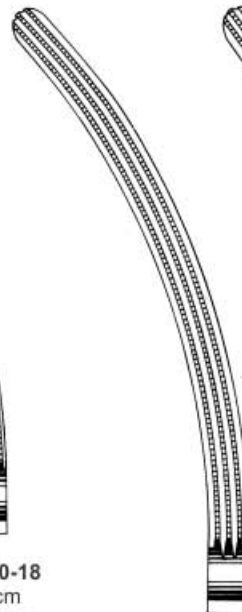

15-221-21
21 cm
Curved

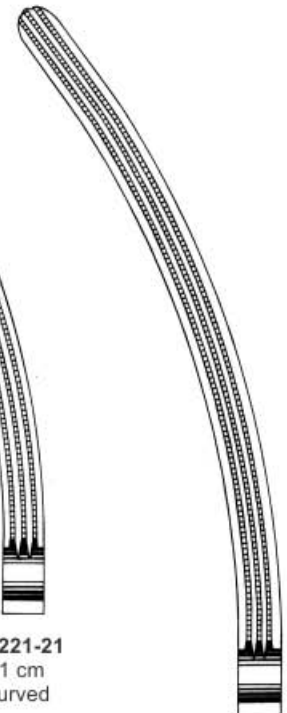

15-222-23
23 cm
Curved



15-223-32



15-224-32



SCUDDER
32cm

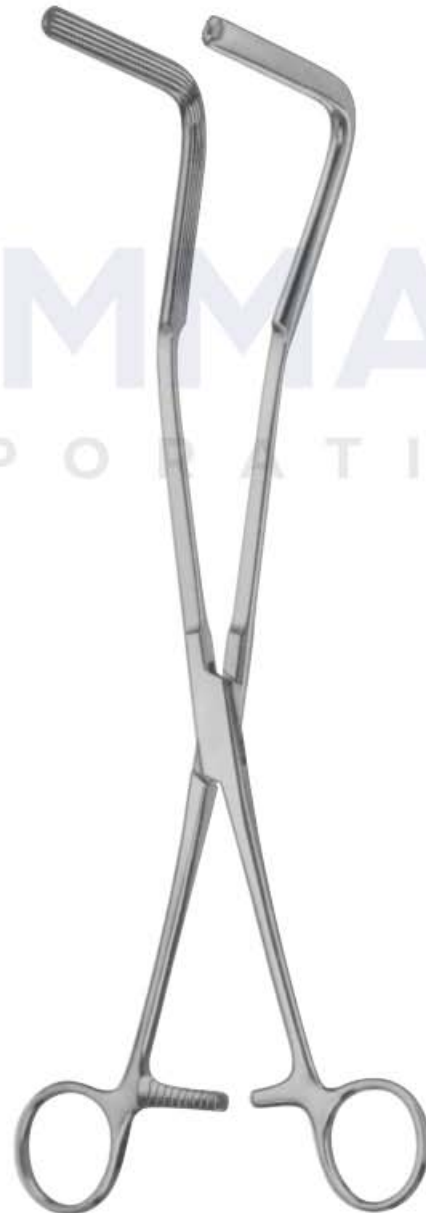

LLOYD-DAVIS
Rectal occlusion forceps
15-225-31 31.5cm

Intestinal & Stomach Twin Clamp Forceps



**Lane Stomach Intestinal
Clamp Forceps**
15-226-30 30 cm
Straight



**Lane Stomach Intestinal
Clamp Forceps**
15-227-30 30 cm
Curved

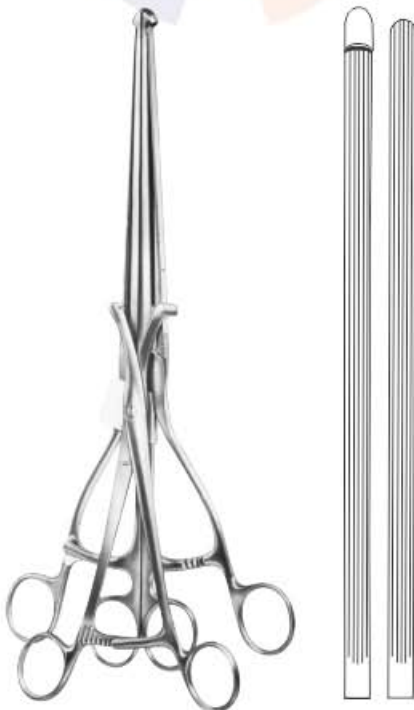

**Haberer Stomach Intestinal
Twin Clamp Forceps**
15-228-36 36cm

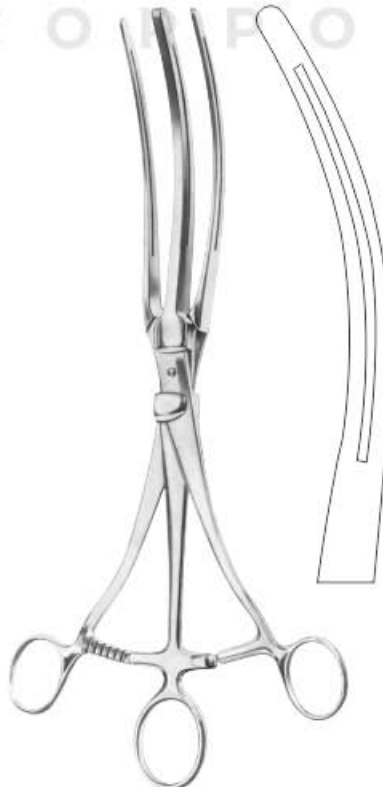

**Roosevelt Stomach Intestinal
Twin Clamp Forceps**
15-229-34 34cm

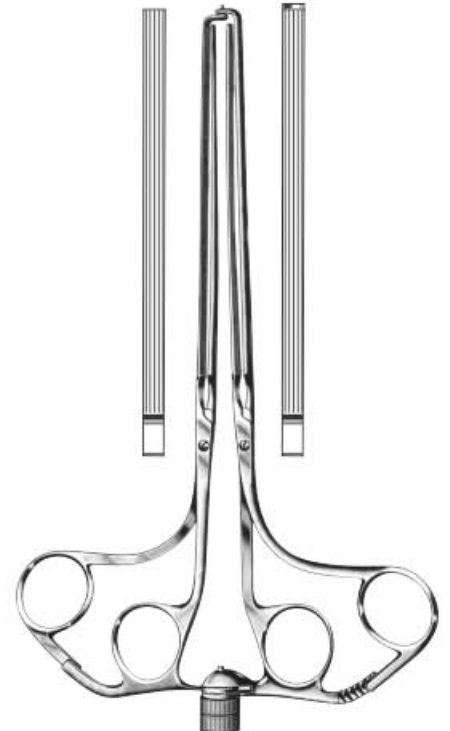

**Abadie Stomach Intestinal
Twin Clamp Forceps**
15-230-22 22cm
15-231-27 27cm



**De Martel-Wolfson
Clamp Holder**
15-232-85 8.5 cm



**De Martel-Wolfson
Clamp Holder**
15-233-23 23 cm



**Stone-Watt
Intestinal Anastomosis Clamp**
15-234-08 8.5cm
15-235-10 10cm



Stone-Watt Closing Forceps
15-236-15
15cm



**De Martel-Wolfson
15-237-00 set of 3
anastomosis clamps**



Jaw length
15-238-05
5 cm



Jaw length
15-239-07
7 cm



Jaw length
15-240-10
10 cm



**De Martel-Wolfson
Closing Forceps**
15-241-26
26 cm



Payr-Baby Crushing Intestinal Clamp
15-242-01
 15 cm
 without pin
15-243-02
 15 cm
 with pin

Payr Crushing Intestinal Clamp
15-244-01
 21 cm
 without pin
15-245-02
 21 cm
 with pin

Payr Crushing Intestinal Clamp
15-246-01
 29 cm
 without pin
15-247-02
 29 cm
 with pin

Payr Crushing Intestinal Clamp
15-248-01
 35 cm
 without pin
15-249-02
 35 cm
 with pin

INTESTINAL RECTAL SPECULA

Mastdarmspekula | Spéculums Rectaux
Especulos Rectales | Specoli Rettali



Mathieu Rectal Speculum
15-250-19 19 cm
90 x 15 mm



Sims Rectal Speculum
15-251-15 15 cm



Sims Rectal Speculum
15-252-15 15 cm

KUMMAS
CORPORATION



Pratt Rectal Speculum
15-253-21 21.5 cm
85 x 25 mm blade

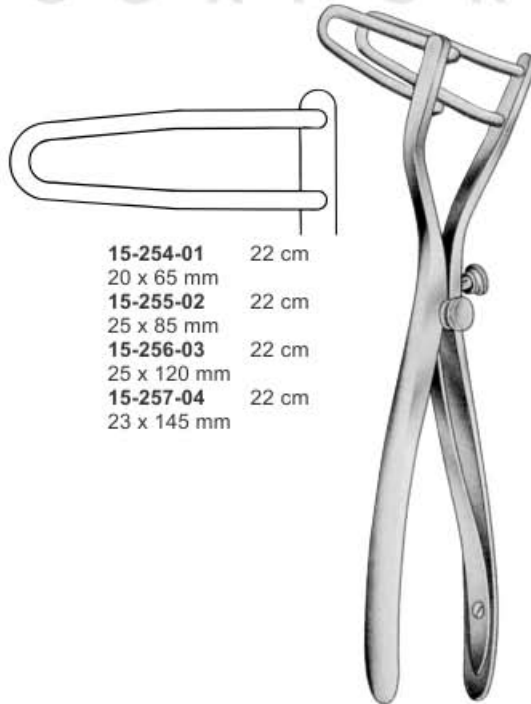

Schulze-Bergmann Intestinal Rectal Speculum

15-254-01	22 cm
20 x 65 mm	
15-255-02	22 cm
25 x 85 mm	
15-256-03	22 cm
25 x 120 mm	
15-257-04	22 cm
23 x 145 mm	

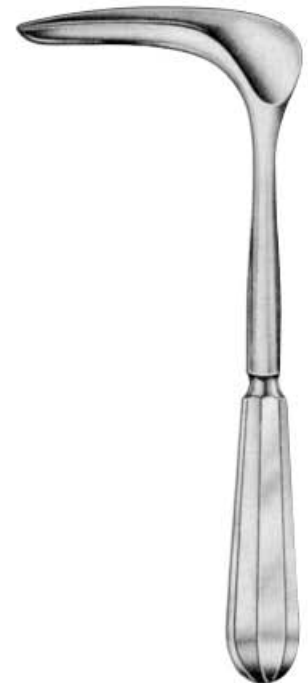

Czerny Rectal Speculum
15-258-22
22 cm



Barr Rectal Spreaders
15-259-00 80mm
Blade size



Smith-Blue Intestinal Rectal Spreaders
15-260-15 15 cm
75 x 23 mm



22mm

15-264-03
Rectal blades
72mm deep
PR = pair



22mm

15-265-04
Sphincter blades
95mm deep
PR = pair



22mm

15-266-05
blades for anastomosis
90mm deep
PR = pair
not included in 15-261-00



Alan-Parks
15-261-00
Rectal spreader
consisting of:
15-262-01 Spreader only
15-263-02 Central blade only
15-264-03 pair of blades only 72mm deep
15-265-04 pair of blades only 95mm deep



15-267-01
 Ø21 x 50 mm
 15-268-02
 Ø27 x 50 mm

**Kelly Rectal
 Speculum**

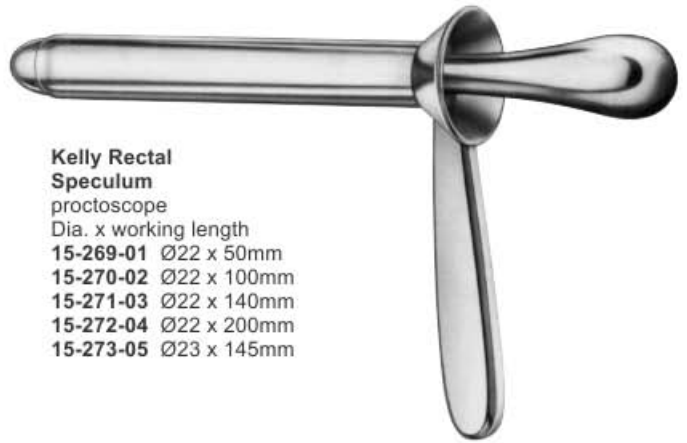

**Kelly Rectal
 Speculum**
 proctoscope
 Dia. x working length
 15-269-01 Ø22 x 50mm
 15-270-02 Ø22 x 100mm
 15-271-03 Ø22 x 140mm
 15-272-04 Ø22 x 200mm
 15-273-05 Ø23 x 145mm



**Barr-Shilford
 Rectal Speculum**
 15-274-01



**Vernon-David
 Rectal Speculum**
 with thumb grip handle
 15-275-01 short handle
 15-276-02 long (standard) handle



**Bensaude
 Rectal Speculum**
 15-277-19 Ø19 x 70 mm
 15-278-22 Ø22 x 70 mm



Brinkerhoff Rectal Speculum
 15-279-01 small 89 x 25mm tapers to 13mm
 15-280-02 medium 101 x 25mm tapers to 15mm
 15-281-03 large 120 x 31mm tapers to 19mm



Fansler Operating Rectal Speculum

with slotted / extra long handle
standard

- 15-282-01 Ø25 mm x 65 mm length
- 15-283-02 Ø29 mm x 65 mm length
- 15-284-03 Ø38 mm x 70 mm length

with slotted tube / short handle

- 15-285-01 Ø29 mm x 60 mm length
- 15-286-02 operating speculum



Chelsea-Eaton Rectal Speculum

solid handle

- 15-287-01 small
 - 15-288-02 large
- with light connection available



KUMMAS
CORPORATION



Hirschman Anoscope Rectal Speculum

- 15-289-01 57 x 14mm inside diameter
- 15-290-02 65 x 16mm inside diameter
- 15-291-03 52 x 17mm inside diameter
- 15-292-04 65 x 19mm inside diameter
- 15-293-05 65 x 22mm inside diameter
- 15-294-06 89 x 22mm inside diameter
- 15-295-07 125 x 22mm inside diameter



Buie Hirschman Anoscope Rectal Speculum

- 15-296-01 57 x 14mm inside diameter
- 15-297-02 95 x 19mm inside diameter
- 15-298-03 98 x 25mm inside diameter

RECTAL SPECULUM, ANOSCOPE

Rektales Spekulum, Anoskop | *espécúlo rectal, anoscopio*
Spéculum rectal, Anoscope | *Speculum rettale, anoscopio*



Ives-Fansler Rectal Speculum
15-299-22 14.5 cm
 22 mm Ø



Ives-fansler Anoscope Rectal Speculum
 with hard rubber obturator /
 fenestrated handle
15-300-22 Ø22 mm x 85 mm



Long Chrome Handle Rectal Speculum
15-301-29 81 x 29mm



Morgen Proctoscope Intestinal Rectal Speculum
 with light connection
15-302-17 Ø17mm
15-303-20 Ø20mm
15-304-24 Ø24mm

POLYOUS GRASPING FORCEPS

Polyous Fasszange

Pinzas de agarre Polyous

Pince à préhension polyous

Pinza da presa Polyous

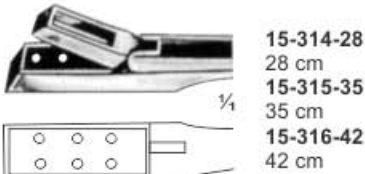
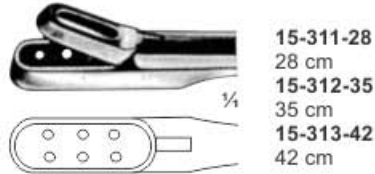
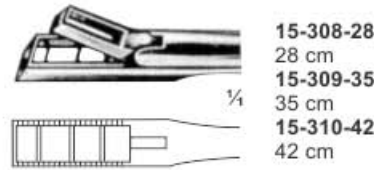
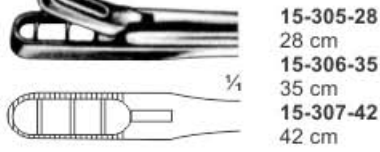
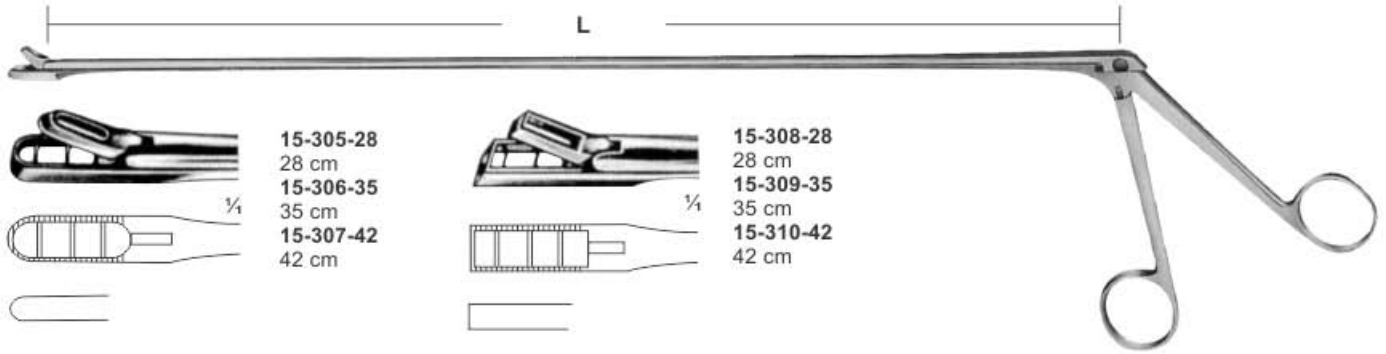

Yeomann Intestinal Polyous Grasping Forceps

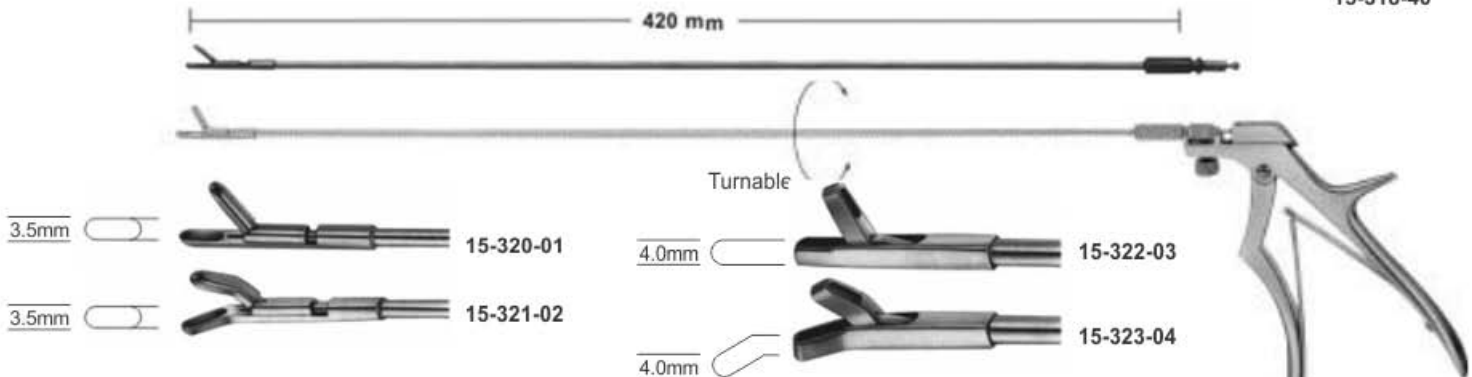
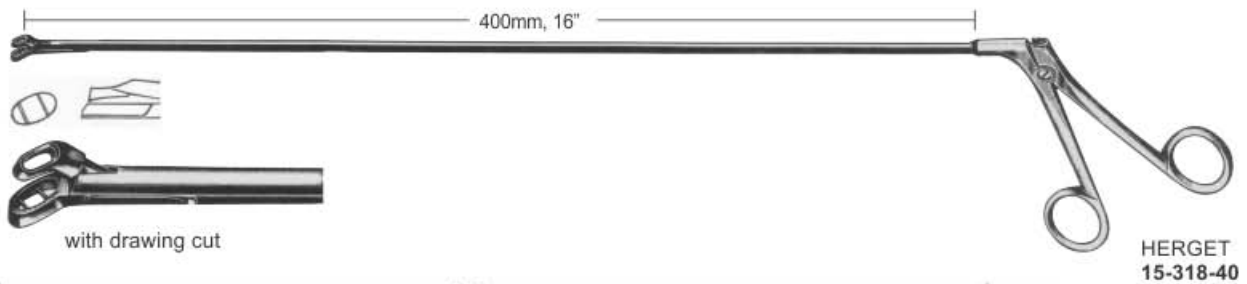

Biopsy Forceps

15-319-00 Handle for 15-320-01 to 15-323-04

HAEMORRHOIDAL LIGATURE INSTRUMENTS

Hämorrhoidalligatur-Instrumente

Instrumentos de ligadura hemorroidal

Instruments de ligature hémorroïdaire

Strumenti per legatura emorroidaria

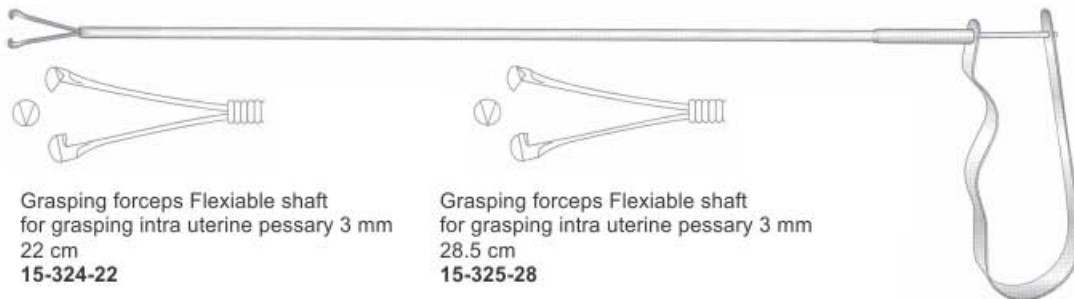

Grasping forceps Flexible shaft
for grasping intra uterine pessary 3 mm
22 cm
15-324-22

Grasping forceps Flexible shaft
for grasping intra uterine pessary 3 mm
28.5 cm
15-325-28



McGivney Hemorrhoidal Ligator forceps with stainless steel con
15-326-19 19cm Working Length.
Barren McGivney Hemorrhoidal Ligator forceps with telon cone
15-327-19 19cm Working Length.

McGivney Hemorrhoidal Ligator forceps with stainless steel con
15-328-18 18 cm Working Length.
Barren McGivney Hemorrhoidal Ligator forceps with telon cone
15-329-18 18 cm Working Length.



McGivney Haemorrhoidal Ligator Complete Set
15-332-00
15-328-18, 15-330-19, 15-331-00



15-330-19
McGivney Haemorrhoid Grasping Forceps
19 cm angled shank.



15-331-00
Ligature rubber rings
in package of 100 pieces

HAEMORRHOIDAL LIGATURE INSTRUMENTS

Hämorrhoidalligatur-Instrumente
Instruments de ligature hémorroïdaire

Instrumentos de ligadura hemorroidal
Strumenti per legatura emorroidaria



Haemorrhoidal Ligator-Suction



15-336-31
Rudd Haemorrhoidal Ligator with loading cone 12mmØ
31.5 cm Straight

15-337-31
Rudd Haemorrhoidal Ligator with loading cone 12mmØ
31.5 cm Curved

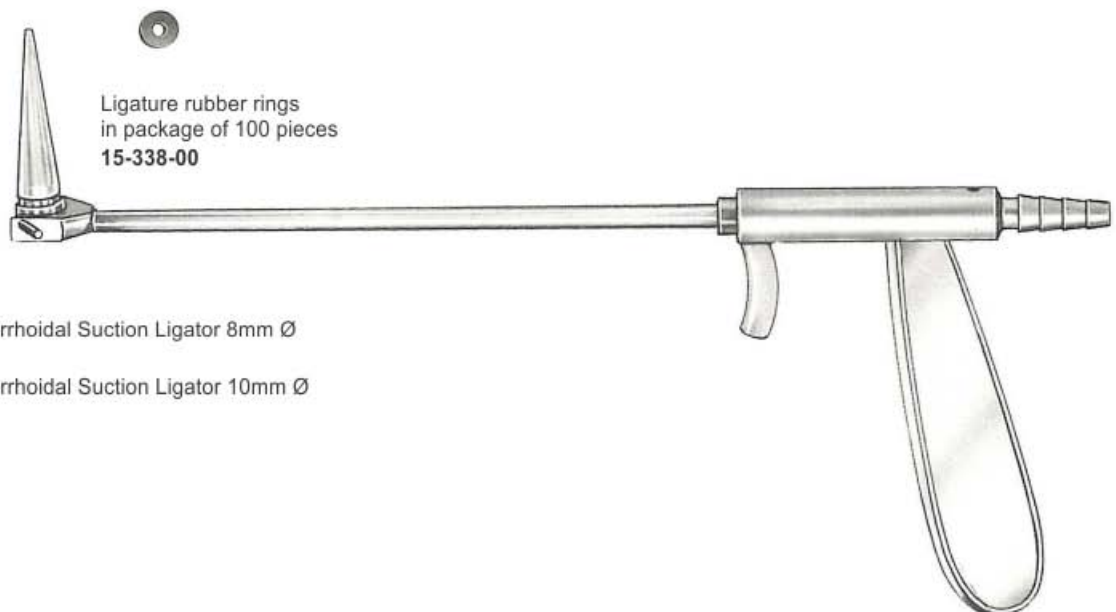

Ligature rubber rings
in package of 100 pieces
15-338-00

15-339-08
Lurz Haemorrhoidal Suction Ligator 8mm Ø

15-340-10
Lurz Haemorrhoidal Suction Ligator 10mm Ø

15-342-01
Ligature Instrument



15-341-00
complete
McGivney modif. Haemorrhoidal
ligator complete with loading cone
and 100 ligature rubber rings



15-345-01
Loading Cone
Teflon



Suction Head
15-346-01 diam. 10mm x 11mm deep
15-347-02 diam. 10mm x 16mm deep



15-343-00
Ligature rubber rings
packet of 100

15-344-01
Ligature Instrument



15-348-00
**Haemorrhoidal
Ligator Suction**
complete
loading cone, 1 each
small and large suction head and
100 ligature rubber rings